

STEP ONE

Align bases with handles facing the back of the Superwall, and white feet on the bottom.

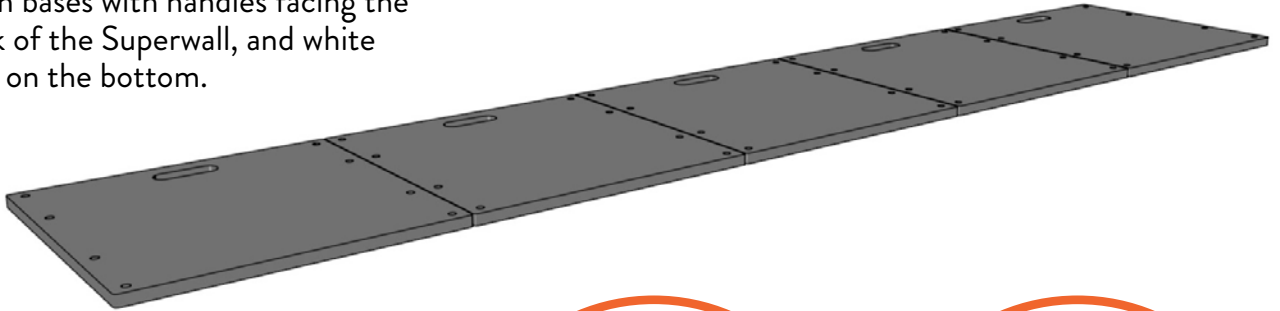

STEP TWO

Connect bases together using C4 connectors as shown. Attach C3 connectors to both ends.

NOTE:

Open Superlever by pulling up on lever, then lock into position by pushing down once inserted into holes. Always ensure that panel/base is flush against connector plate.

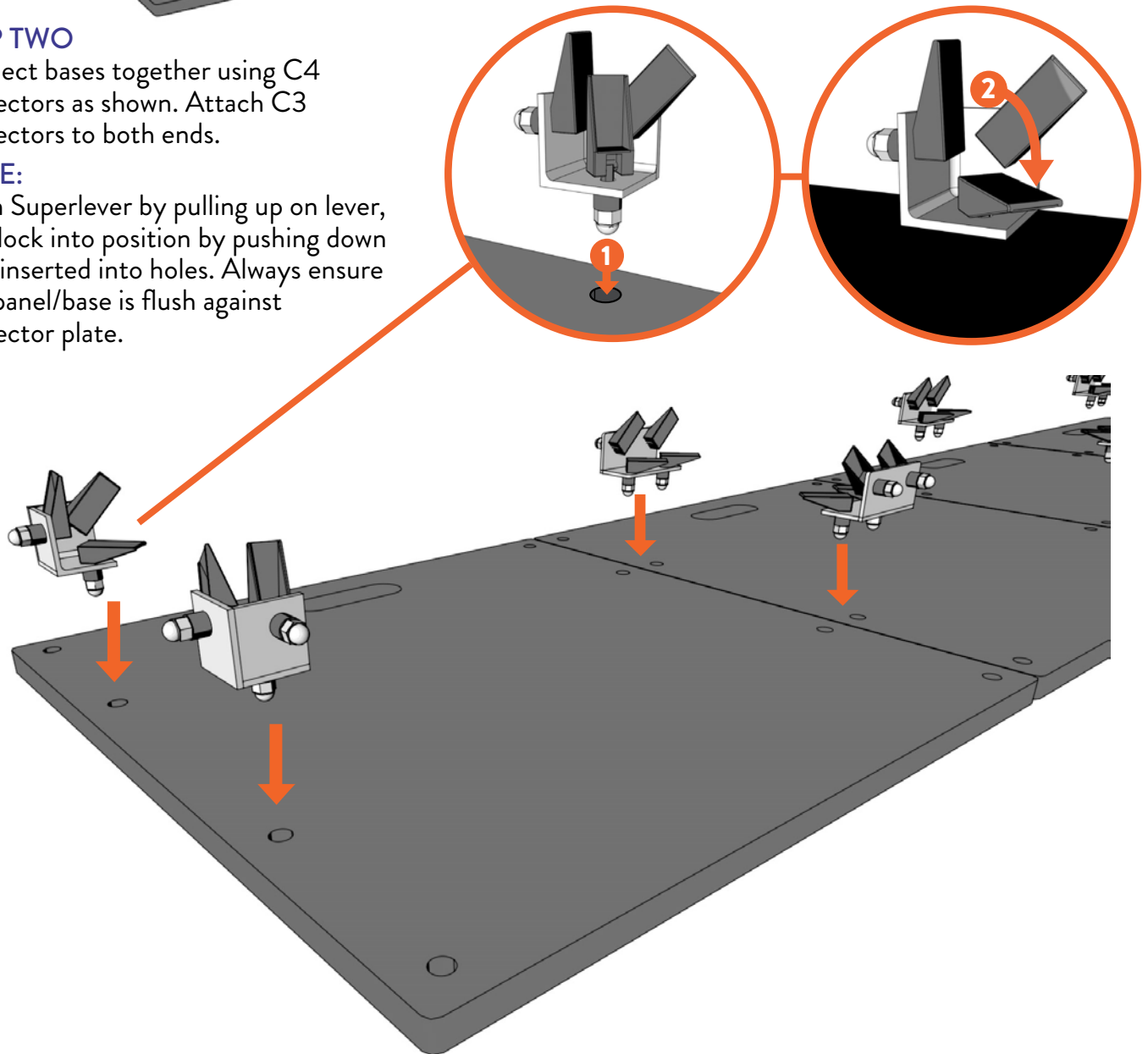

STEP THREE

Attach Superlever panels to C4 and C3 connectors as shown. Attach Half panels to C3 connectors at each end of Superwall.

NOTE:

To add lights inside Superwall use Mousehole panels to allow lighting cables to pass through.

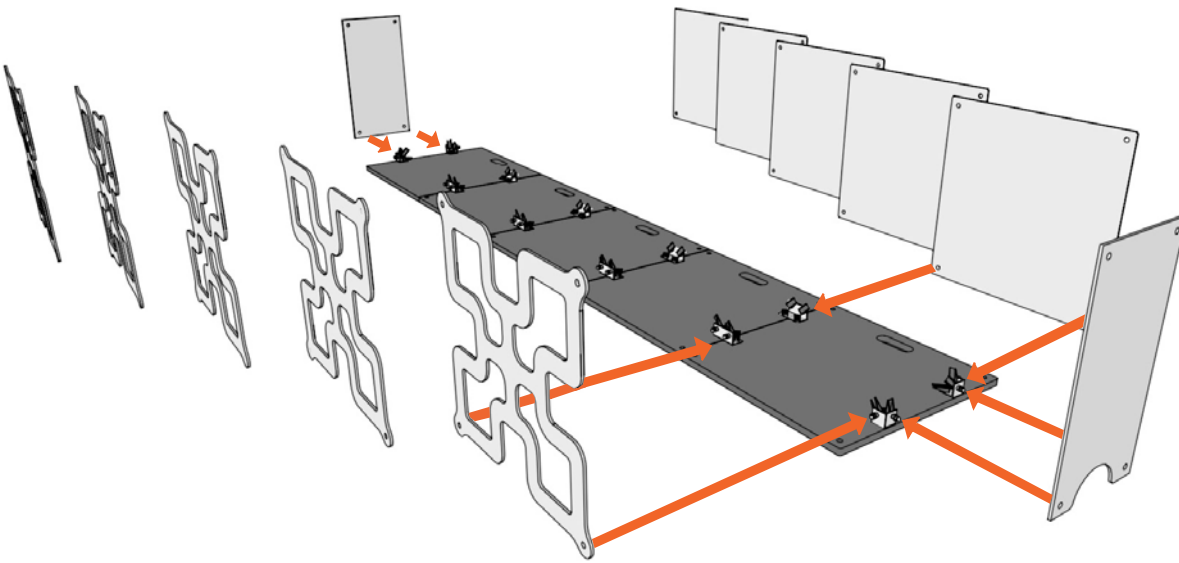

STEP FOUR

Connect Superlever panels and Half panels using C4 connectors at each end. Connect the front and back of the Superwall using Dogbone connectors. Continue attaching Superlever panels, Half panels, C4 and Dogbone connectors for each row of the Superwall. Note orientation of panels to build according to designed pattern.

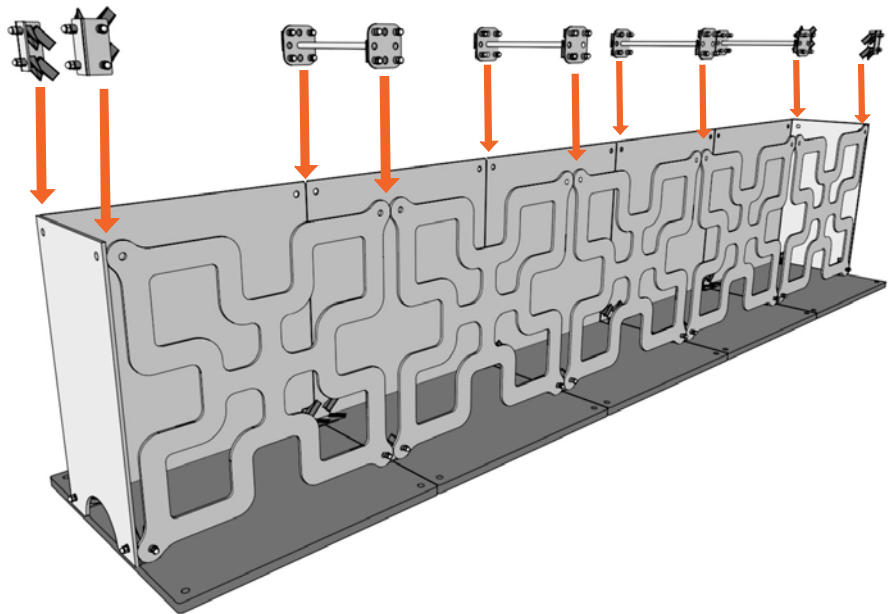

STEP FIVE

For top of Superwall, attach C3 and C4 connectors as shown.

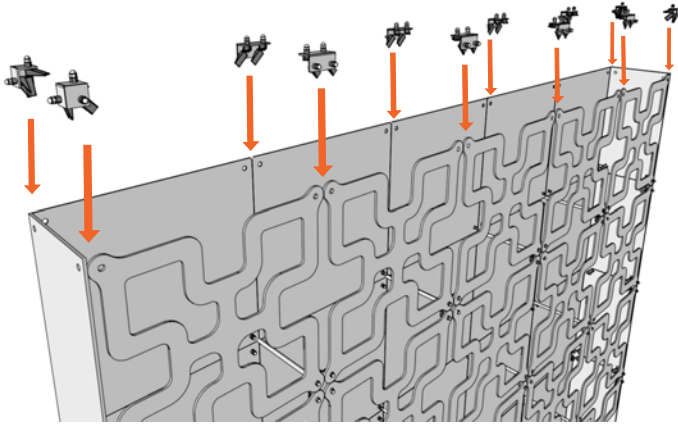

STEP SIX

Complete Superwall by attaching Half panels to the top of the Superwall. Ensure structure is stable before repositioning.

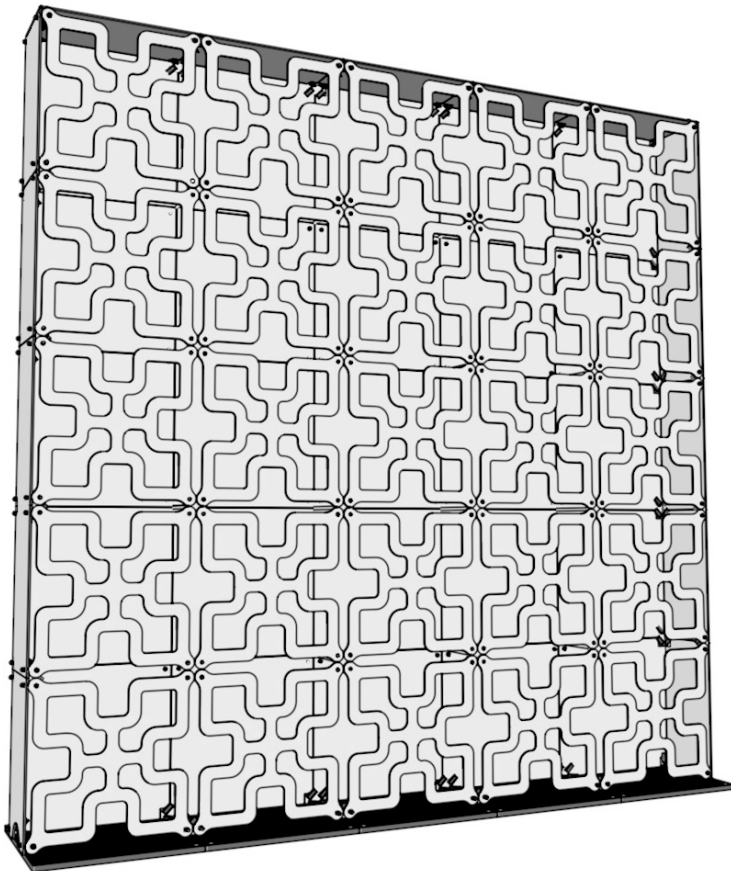
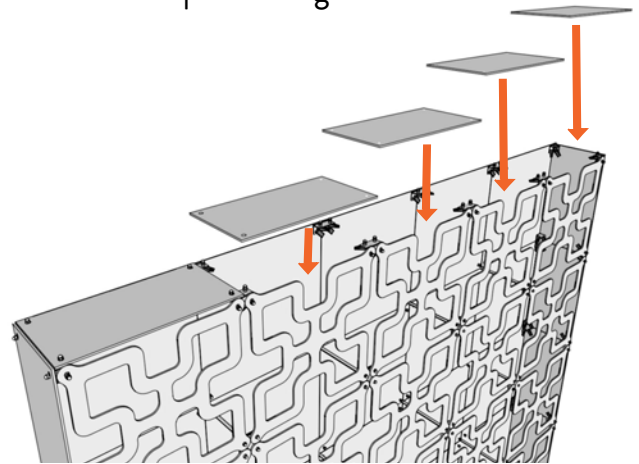

DISASSEMBLY INSTRUCTIONS:

Superwall **MUST** be disassembled from top down, in reverse order as the assembly process. Removal of bottom panels first may result in a collapsing wall.